

NANOG History (v0.2)

William B. Norton
Co-Founder/Chief Technical Liaison
Equinix, Inc.
wbn@equinix.com

Not Vetted – there will be mistakes!

What do I know about NANOG?

- Merit Staff – 1987-1998
- NANOG Chair 1995-1998
- Developed 1st Business Plan for NANOG
 - Financially Self-sustaining
- Started number of NANOG traditions
 - NANOG T-Shirts
 - Numbering NANOGs
 - Colored NANOG NameTag
 - Beer-n-Gear
 - Cookie graph
 - Surveys
 - Etc.

Price Per Cookie 🍪

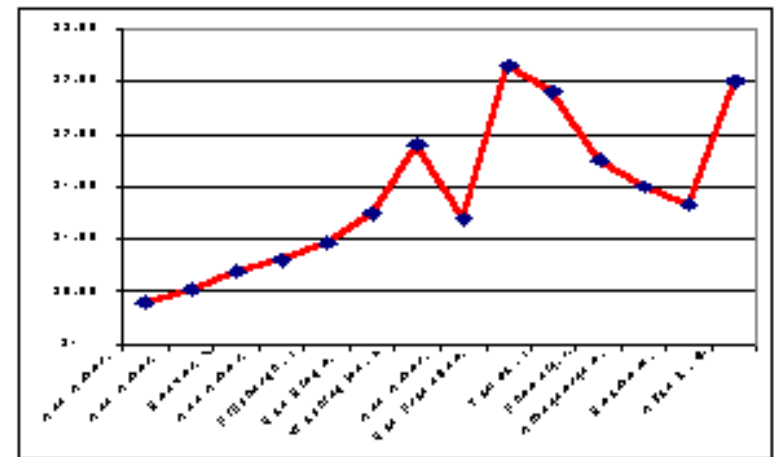

But, THESE SLIDES ARE NOT VETTED.
Probably are mistakes in here.

Terryr: What can I expect?

Q: What to expect in a typical day?

A: Current Meeting Structure

- 2.5 days – it may look like a terminal room...

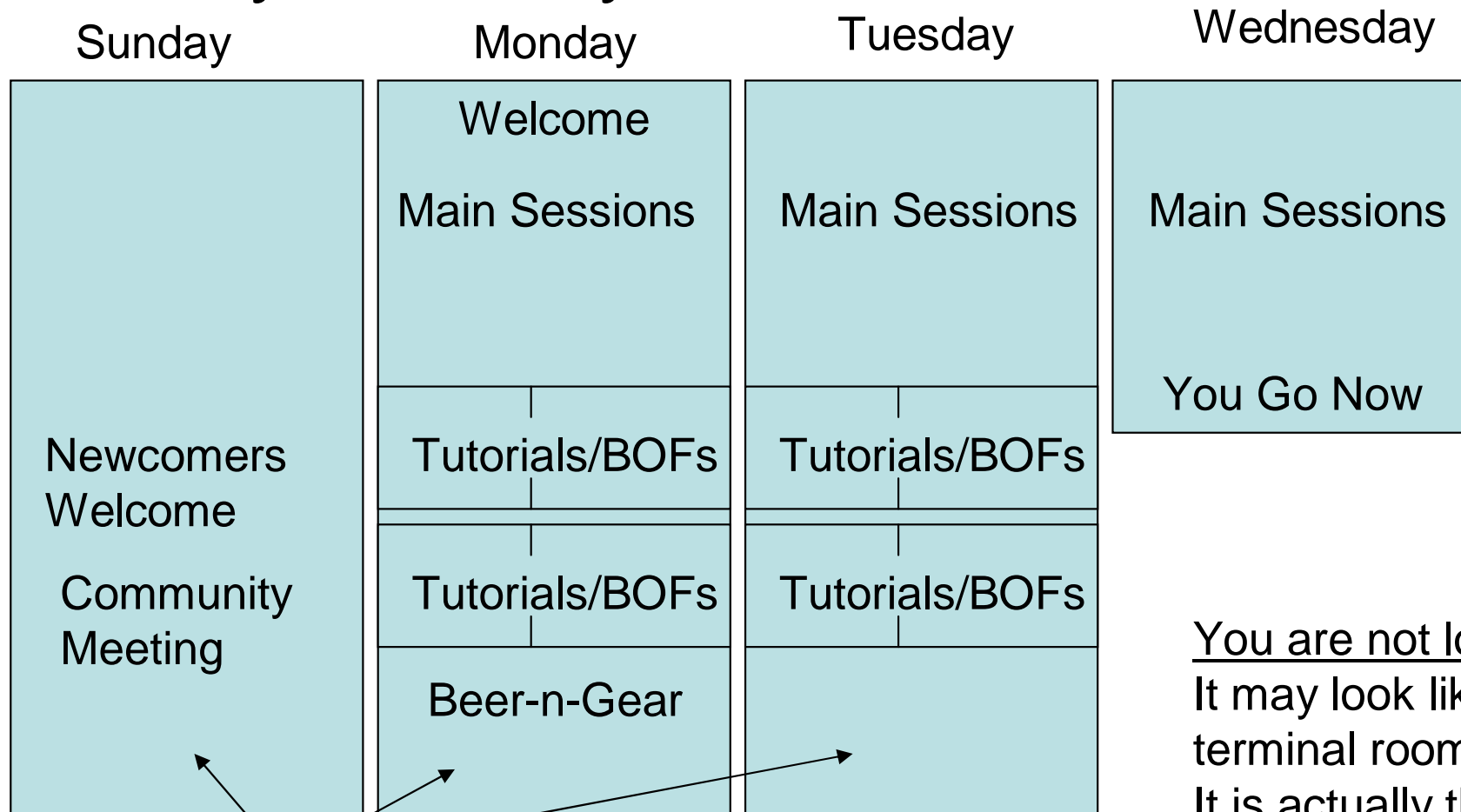

Evenings Free

You are not lost!
It may look like a terminal room, but
It is actually the
NANOG Plenary Room.

Distribute travel costs...

NANOG Spreads Travel Burden

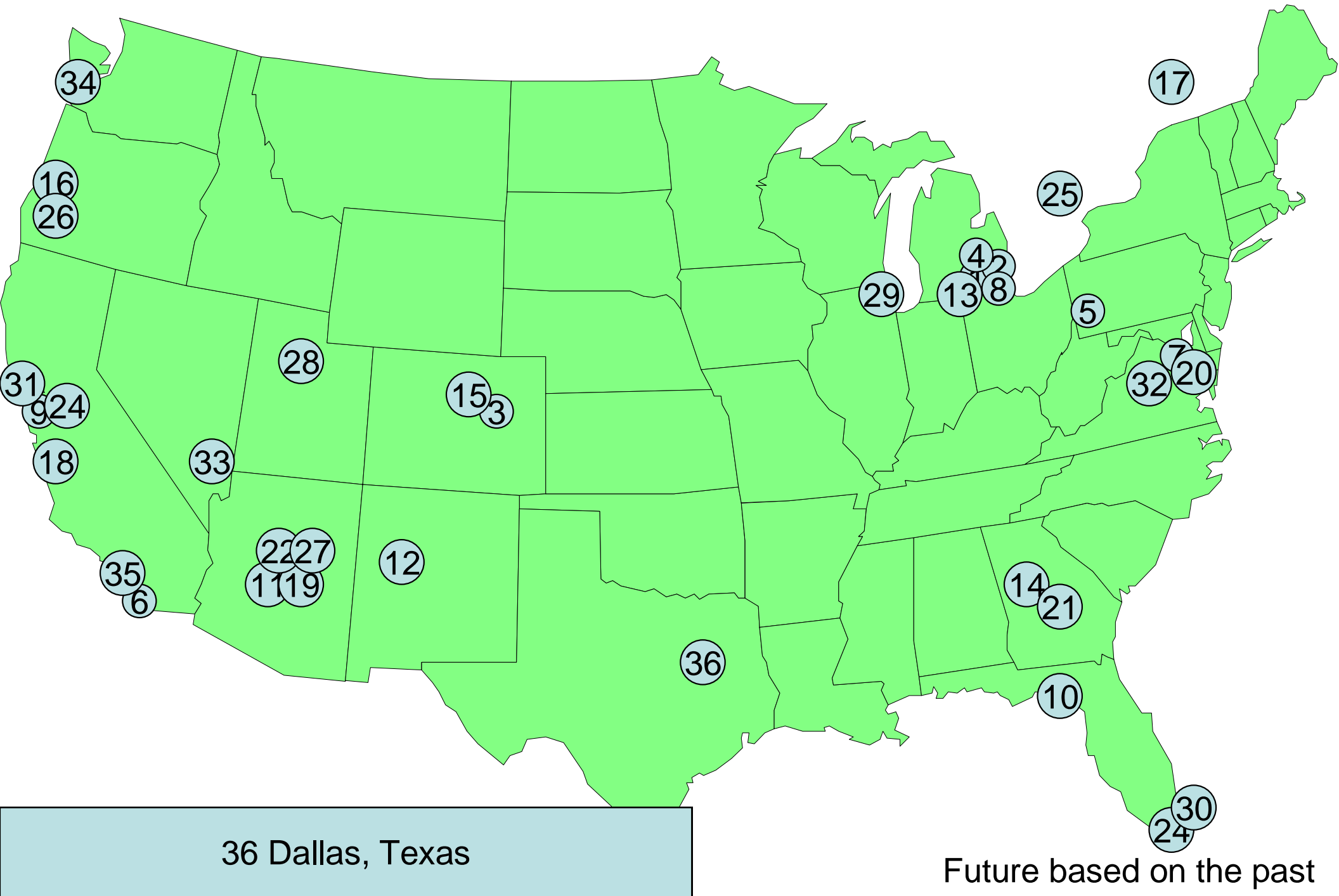

NSF funded
\$

1987-1994

Merit

Logistics
Host

Regional Techs Meetings

Agenda

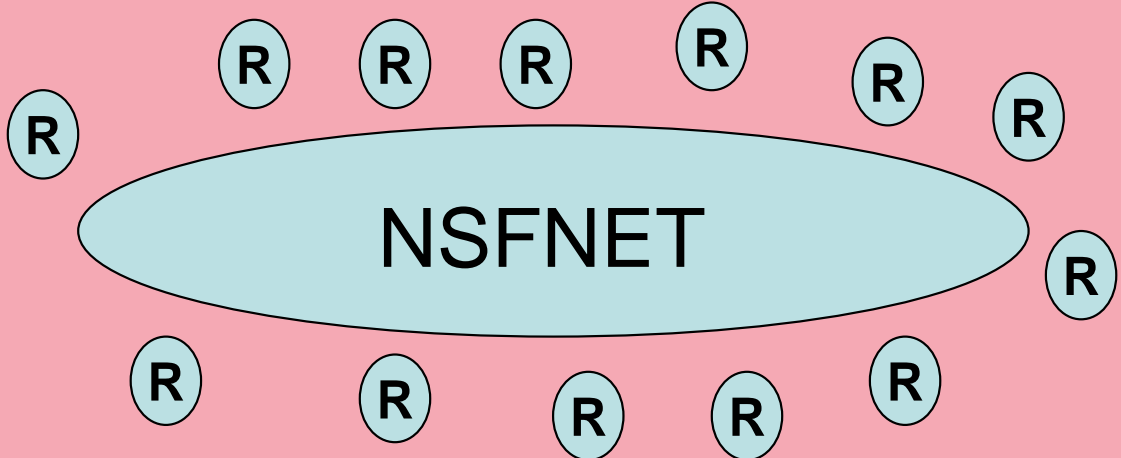

Then the Internet crew

NSF funded
Self-sustaining
\$

1987-1994

Merit

Logistics
Host

**Regional Techs Meeting
North American
Network Operators
Group (NANOG)**

Agenda

Commercial Internet

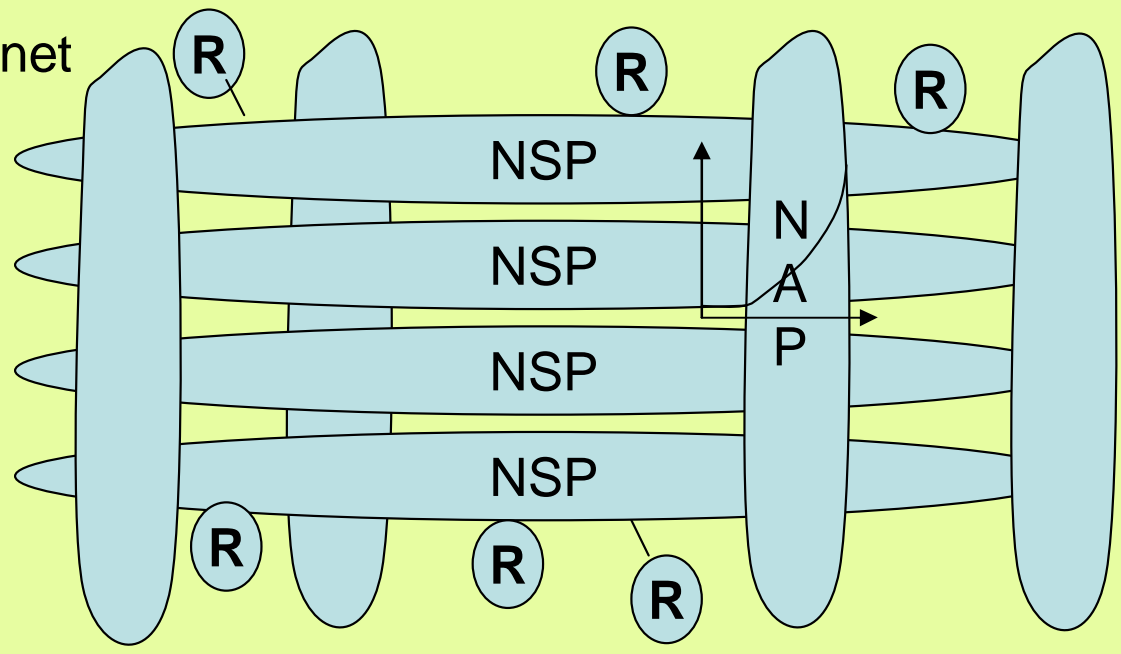

1994

\$ Self-Sustaining

Merit

Logistics

Host

Agenda

NANOG Meetings
NANOG WebSite,
nanog Mail

Worse than your jokes!

Commercial Internet

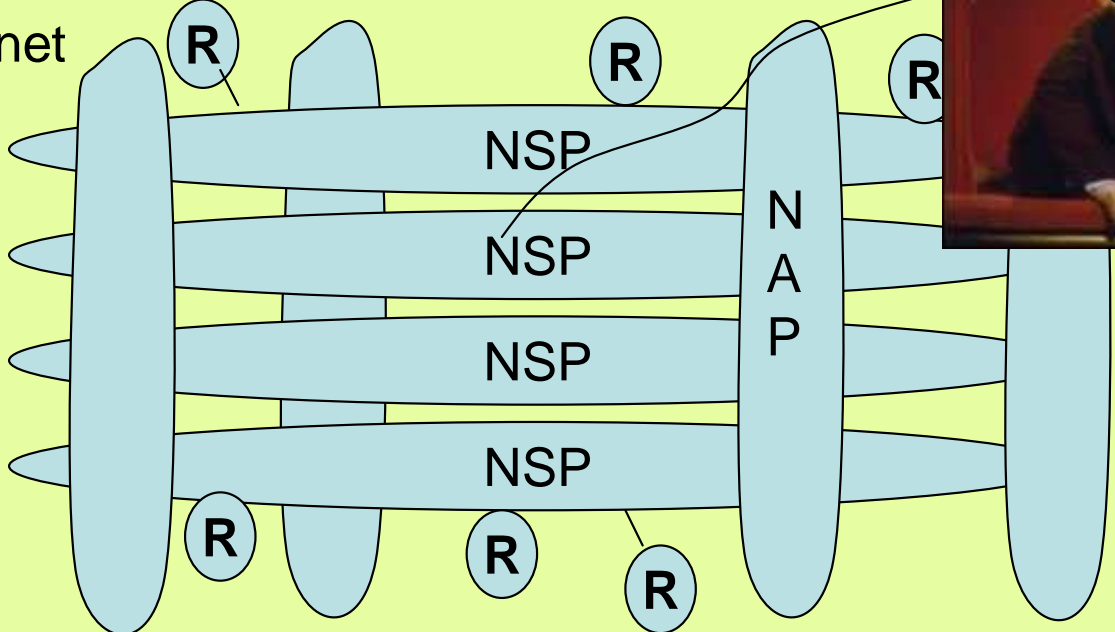

1998-2004

- For a variety of reasons, NANOG restructuring started in 2004
- Desired Structure should provide
 1. Transparency
 2. Accountability
 3. Better Agenda
 4. Be Community-Driven and Responsive

Re



ire

NANOG Charter

Revised June 15, 2005

- **St**

1. Preamble

- **Pr**

The North American Network Operators' Group (NANOG) exists to promote dialog between people concerning the creation, maintenance and operation of Internet Protocol networks. NANOG is not itself a network operator—rather, it is a facilitator of discussion, learning, and technical communication between networking professionals. NANOG provides a forum where people from the network research community, the network operator community and the network vendor community can come together to identify and solve the problems that arise in operating and growing the Internet.

- **Me**

2. Name

The name of the activity is the North American Network Operators' Group (NANOG).

3. Mission

The purpose of NANOG is to provide forums in the North American region for education and the sharing of knowledge for the Internet operations community.

NANOG is a small venue in which technical matters pertaining to network operations and network technology deployment in Internet providers may be discussed among experts. Such discussions have in the past focused on, but are certainly not limited to, experiences with new protocols and backbone technologies, implications of routing policies on the Internet as a whole, measurement techniques and measurements of Internet health and performance, areas in which inter-provider cooperation can be mutually beneficial (such as NOC coordination or security incident response), and maintaining a competitive and level business environment.

Source: <http://www.nanog.org/charter.html>

2005-2006

\$ Self-Sustaining

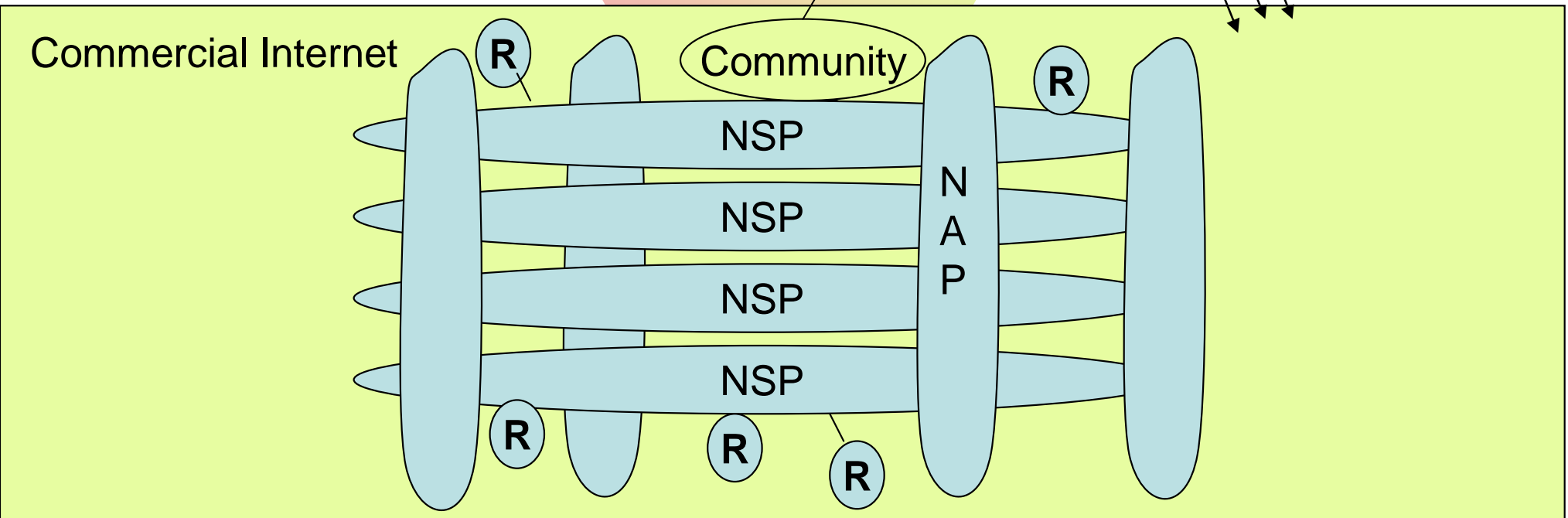
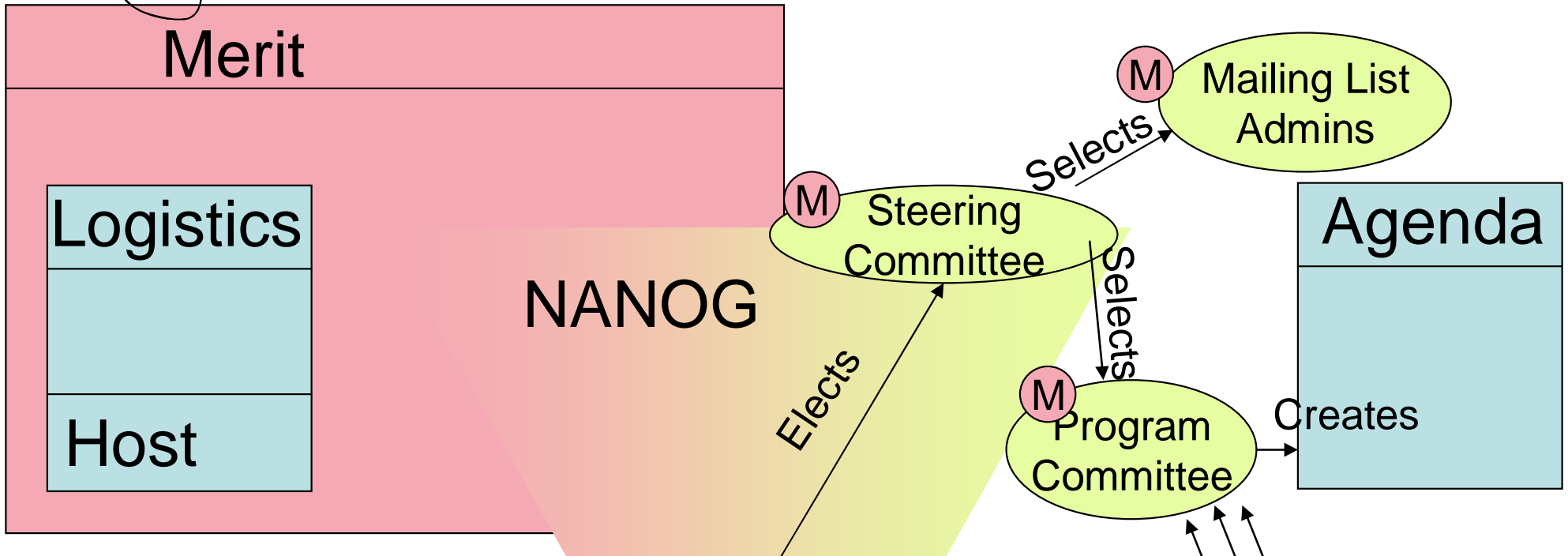

Results

- Transparency
 - Each groups members/activities documented
 - Meeting Minutes
 - Community Meeting for discussions
- Community-Driven Agenda
 - PC actively recruiting talks
- Accountability
 - elected steering group
 - Accessible at NANOG, e-mail aliases

A quick review of NANOGs Past

- NANOG Folklore

NANOG Meeting Column

DRAFT TWO

The North American Network Operations Group (NANOG) remains our best bet for managing through the Internet's coming collapses. Problem is, like the Internet, NANOG itself is struggling to scale up.

I've just been among the 350 mostly engineers attending NANOG's May meeting at George Washington University. It's clear now, even if they hate the idea, that if NANOG is to lead us toward an industrial-strength Internet, then it must now urgently attract the active participation of many more men and women who routinely wear suits.

Here, on April Fool's Day, I nominated NANOG as that organization best positioned to lift the Internet out of its current, dysfunctional operations anarchy. I then incorrectly identified NANOG as part of the Internet Society's Internet Engineering and Planning Group (IEPG), a seemingly defunct sister of the Internet Engineering Task Force (IETF). Turns out I was wrong about what I'd read on the Web at <http://info.isoc.org/adopsec>.

For the next two weeks postings on NANOG's message archive flamed me for not knowing that NANOG is moderated by the Merit Network at the University of Michigan (<http://www.merit.edu/>). NANOG, I was told, has nothing to do with the Internet Society. And further, the Internet Society has nothing to do anymore with the IETF.

Checking with a pal at the Society, I was told that IETF has been arguing about disassociating from the Internet Society, and, oh by the way, Merit is "irrelevant."

Yes, I found pettiness and bureaucratic infighting among the groups I had hoped would be pulling the Internet together. I stand corrected, but not reassured.

Back at NANOG. I was surrounded by people whose life is about "running

A little bicaer...

Bob Metcalfe/InfoWorld

- “I've just been among the 350 mostly engineers attending NANOG's May > meeting at George Washington University. It's clear now, even if they hate > the idea, that if NANOG is to lead us toward an industrial-strength > Internet, then it must now urgently attract the active participation of > many more men and women who routinely wear suits. “

Back of Shirt

Front of Shirt:

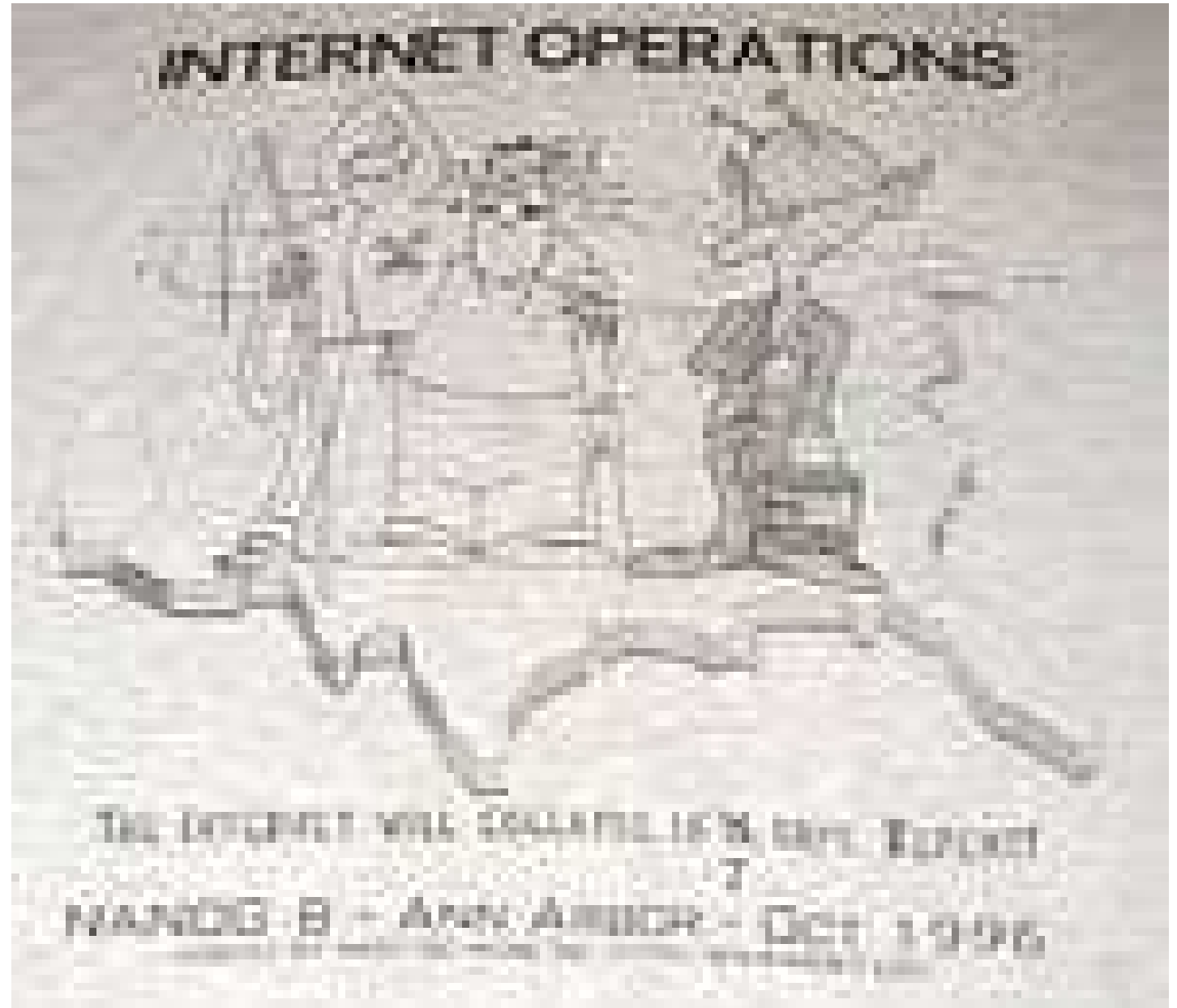

Bob Metcalfe & NANOG

Dear NANOG List,

Thanks for your critiques of my NANOG meeting critique column in InfoWorld.

Below is a copy of a draft (before editing) of the offending column, just in case some of you have been reading only one another's critiques instead of the column itself. ~~Of course I stand by it.~~

Some of you guys/gals are very good at ad hominem attacks. Flaming is alive and well on the Internet. Tisk tisk. But then I asked for it. Anyway, the attention is flattering. Thank you.

A few of you missed one point at least. I am NOT suggesting that any of YOU start wearing suits, especially if you find them uncomfortable, or that they make a statement you are not willing to make -- none of that, no -- good engineers are too valuable to overdress. I am suggesting that more of the kind of people who ALREADY wear suits should start paying attention to the important work NANOG is attempting and start attending your meetings so they can pitch in on the non-engineering aspects of operating the Internet. Is that clearer now?

By the way, there are reports from two days ago that 400,000 people lost their Internet access for 13 hours. Sounds like an outage approaching "collapse." Was that just a Netcom thing that NANOG has no interest in? Netcom is not talking very much about what happened. Any clues/facts out there? Were any NAPs involved?

/Bob Metcalfe, InfoWorld

Famous Quotes Page

- **Internet** – "I predict the Internet will soon go spectacularly supernova and in 1996 catastrophically collapse."
-- *Robert Metcalfe, founder of 3Com and inventor of Ethernet (1995)*

On the same web page:

- **Computers** – "There is no reason for any individual to have a computer in their home."
 - *Kenneth Olson, founder of Digital Equipment Corporation (1977)*
- **Computers** – "640 K [of computer memory] ought to be enough for anybody."
 - *Bill Gates, founder and CEO of Microsoft (1981)*
- **Computers** – "By 1990 75-80 percent of IBM compatible computers will be sold with OS/2."
 - *Bill Gates, founder and CEO of Microsoft (January, 1988)*

Metcalfe Eats his words

Friday April 11 4:27 AM EDT

- Sage who warned of Net's collapse eats his words SANTA CLARA, Calif., April 10 (Reuter) - The networking pioneer turned computer industry columnist who predicted the Internet would collapse last year, Thursday kept to his promise by literally eating his words.
- Bob Metcalfe, inventor of Ethernet technology and founder of 3Com Corp , had pledged he would eat the words from a December 1995 InfoWorld column he wrote if the dramatic debacle he predicted did not come to pass.
- In the column, Metcalfe warned of a "catastrophic collapse" of the Internet in 1996.
- He made the original vow at a conference of World Wide Web engineers and enthusiasts in Boston in 1995, and he argued here before the Sixth International World Wide Web Conference Thursday that the Web had logged major outages. Metcalfe said that outages at Netcom On-Line Communications Services Inc , A

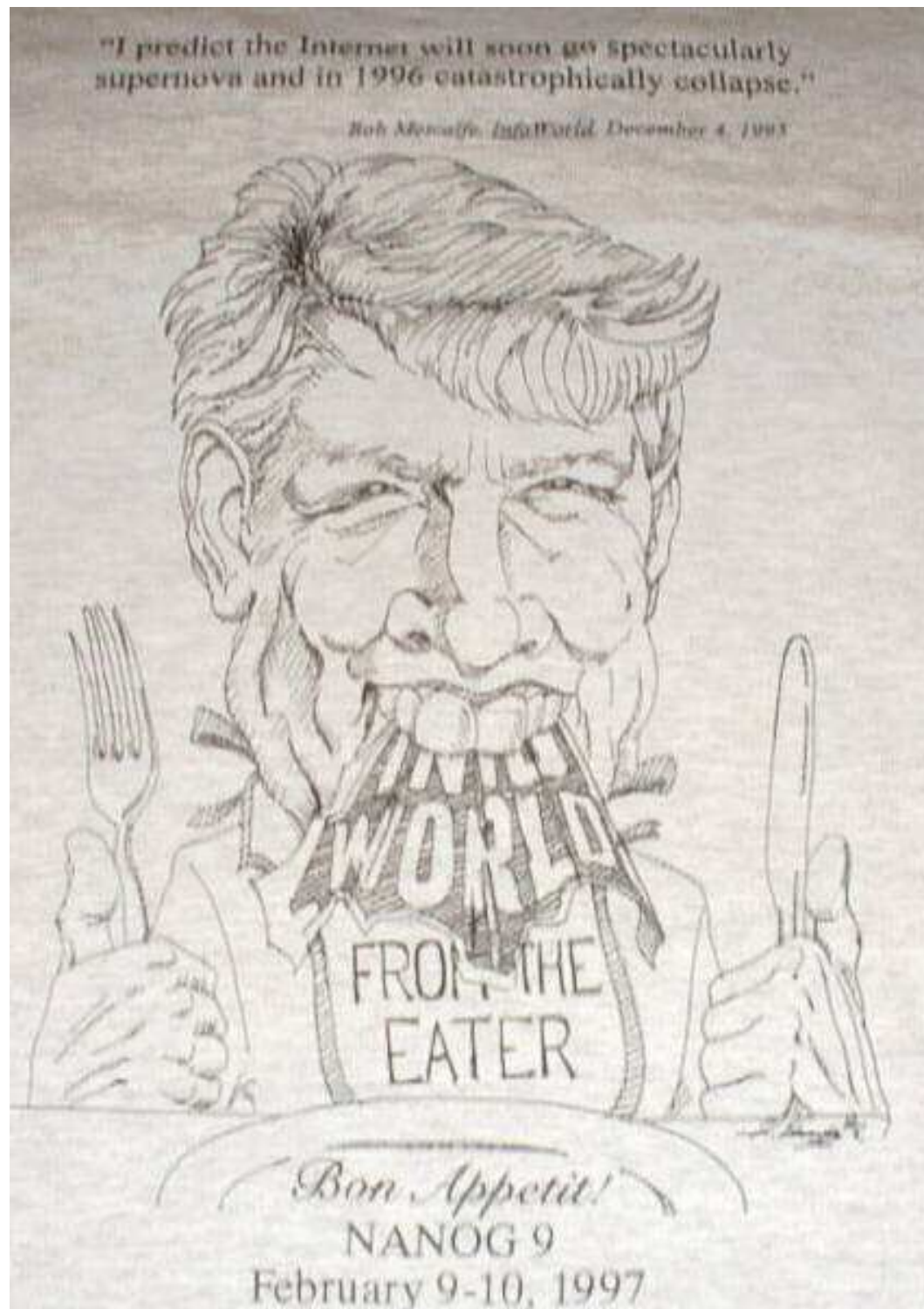

1997



NANDG 10 - Tampa, Florida - June 1997
Hosted by IBM Global Services

Internet Operations 1997: Backhoes in Concert

June 3 Lynchburg, VA
July 16 Los Angeles, CA
July 17 Washington, D.C.
July 18 Los Angeles, CA
July 22 New Orleans, LA
July 25 Sterling, VA

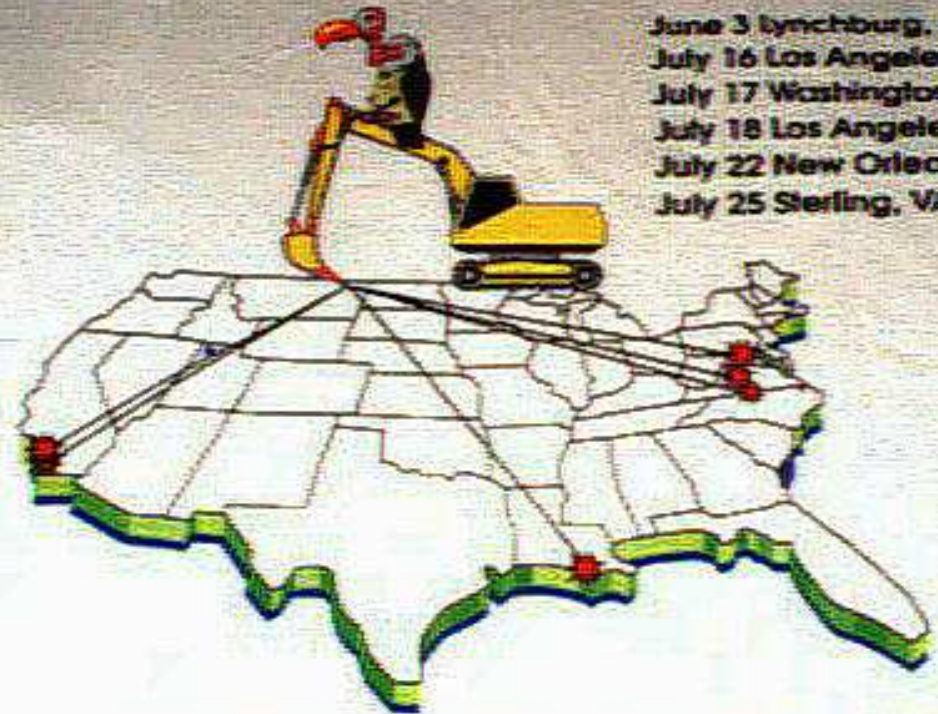

NANDG 11 - PHOENIX, AZ - OCT 1997
HOSTED BY GENUITY INC. [HTTP://WWW.GENUITY.NET](http://www.genuity.net)

1998

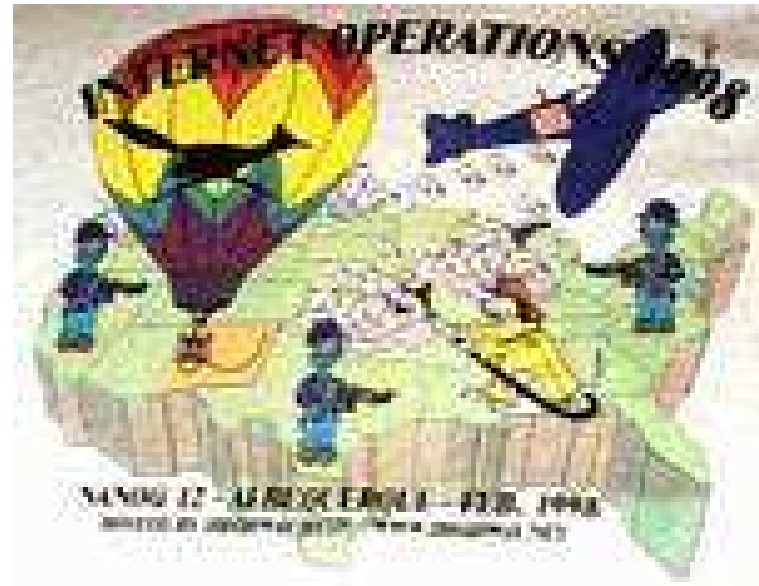

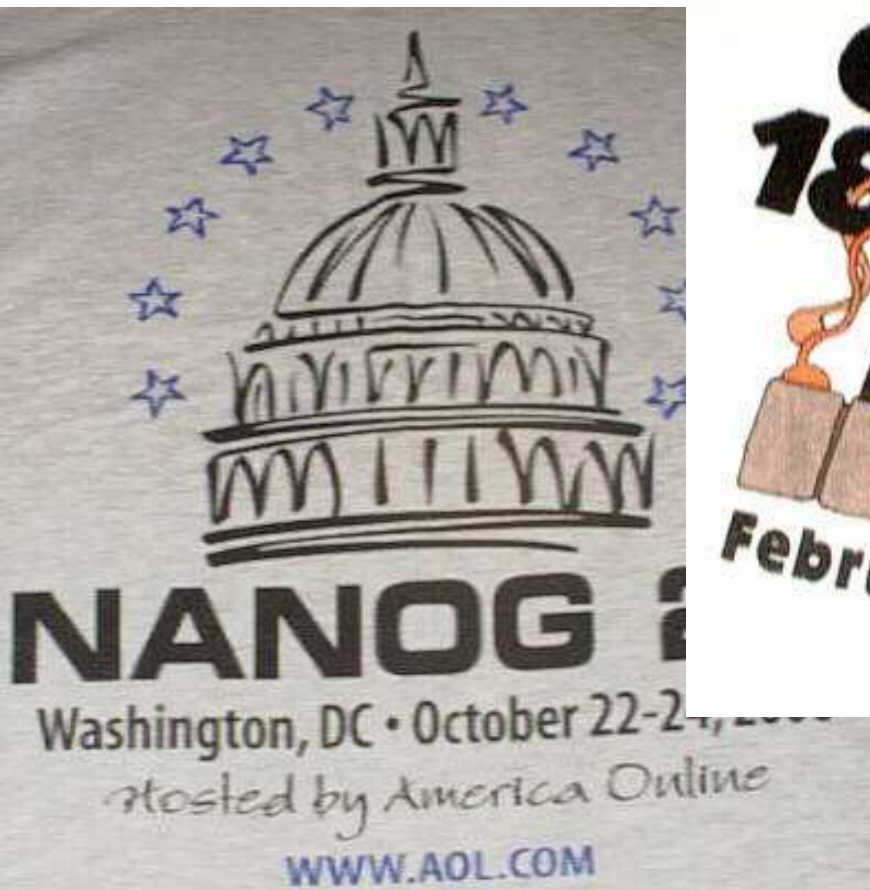

NANOG 21



February 18-20, 2001
Atlanta, Georgia

Hosted by Riverstone Networks
www.riverstonenetworks.com

NANOG 22

Scottsdale, Arizona
May 20-22, 2001



Long-Necked Fiber Eater
Sponsored by CenterGate Research

NANOG 23

Seattle, WA
October 20-22, 2001

Country	City	Start	End
USA	Seattle, WA	Oct 20	Oct 22
USA	Atlanta, GA	Feb 18	Feb 20
USA	Washington, DC	Feb 25	Feb 27
USA	Minneapolis, MN	Jan 29	Jan 31
USA	San Jose, CA	Apr 23	Apr 25
USA	Woodstock, VA	Mar 11	Mar 13
USA	Eugene, OR	May 21	May 23
USA	Seattle, WA	Jan 23	Jan 25
USA	Atlanta, GA	Mar 26	Mar 28
USA	Seattle, WA	Jan 14	Jan 16
USA	Minneapolis, MN	Feb 19	Feb 21
USA	Florida, FL	Oct 20	Oct 22
USA	Tampa, FL	Jan 11	Jan 13
USA	San Francisco, CA	Apr 16	Apr 18
USA	San Diego, CA	Mar 26	Mar 28
USA	Washington, DC	May 21	May 23
USA	San Diego, CA	Feb 19	Feb 21
USA	Providence, RI	Apr 11	Apr 13
USA	San Diego, CA	Apr 23	Apr 25
USA	Seattle, WA	Feb 19	Feb 21
USA	San Diego, CA	Oct 20	Oct 22
USA	San Diego, CA	Jan 11	Jan 13

Open Systems



www.opens.com

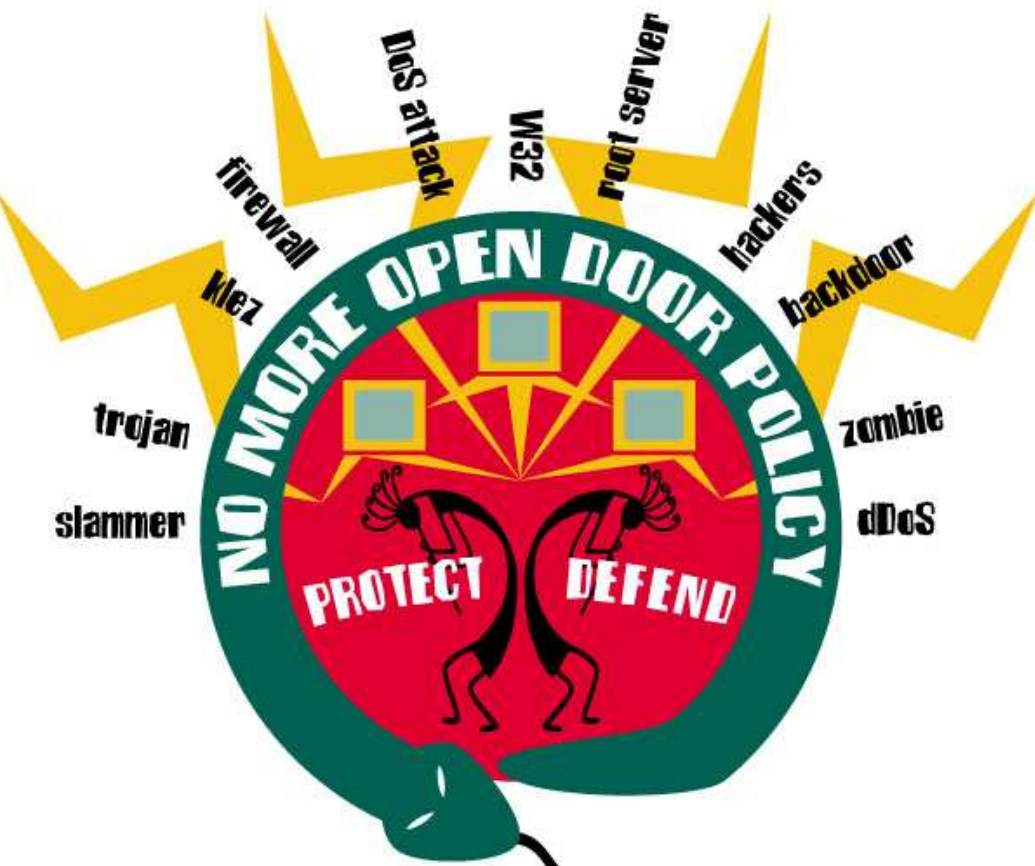
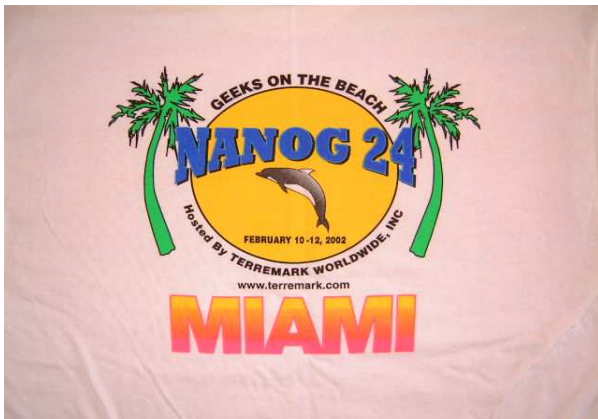

NANOG 27
 Hosted By UltraDNS
 Phoenix, AZ • February 9-11, 2003

<http://www.nanog.org/nanog-tshirts/nanogtees.html>

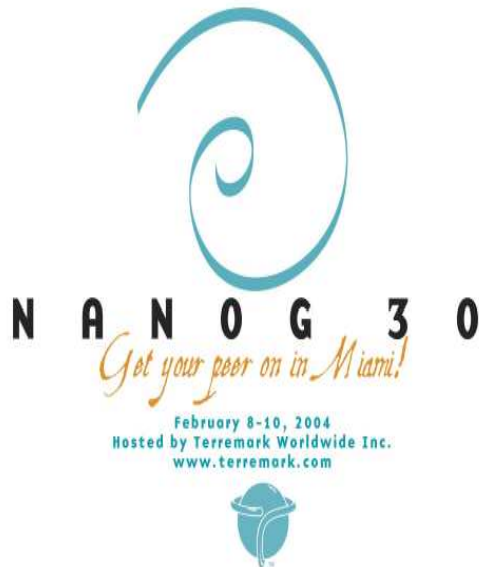

May 23-25, 2004
San Francisco



Hosted by CNET Networks
www.cnet.com



NANOG 32

RESTON VIRGINIA • OCTOBER 17-19, 2004
HOSTED BY AOL AND TIME WARNER CABLE



My Suggestions for You

- Every Conference is the same:
 - 1st time, you know no one
 - 2nd time, you recognize someone
 - 3rd time, someone recognizes you
 - ... send the same person each time
- You won't understand everything
 - Spend time in the hallways
 - (Big) Part of the benefit of NANOG is meeting the Community